

TaylorMade
Solutions
are welcome!

wittig

Capacitor Holder

Capacitor Spacer

Capacitor Washer

Capacitor Insulation

Capacitor Accessories



www.wittig-electronic.de

Capacitor Spacer



E-CAP Spacer p.5

Material: Nylon66
Flame class: 94V-2
Color: Black

PART NO	A	B	C
ECS-001	Ø10.0	5.0	7.0

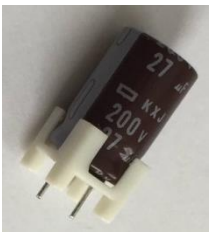
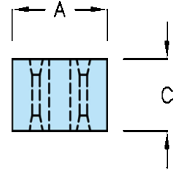
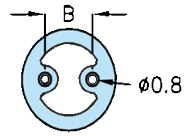

E-CAP Spacer p.5

Material: Nylon66
Flame class: 94V-0
Color: Natural

PART NO	A	B	C
90F10160	10.0	10.0	8.0

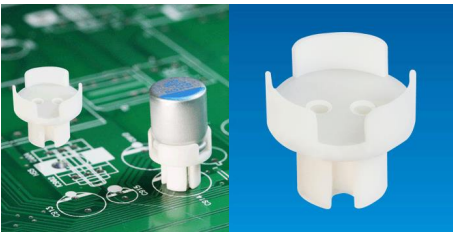
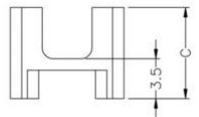
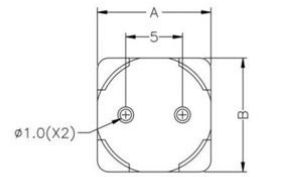

E-CAP Spacer p.5

Material: Nylon66
Flame class: 94V-2
Color: Natural

PART NO	A	B	C
ECS-002	Ø11.0	Ø10.0	10.0

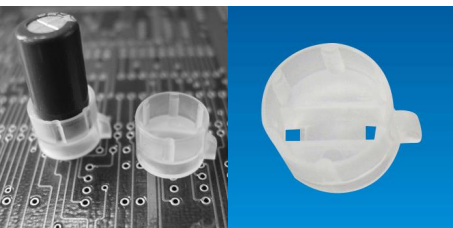
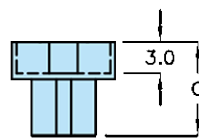
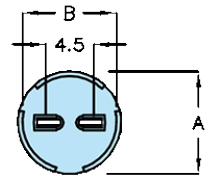

E-CAP Spacer p.5 enlarge to p.10

Material: PP
Color: Natural

PART NO	A	B	C
ECS-003	Ø12.5	Ø10.2	9.2

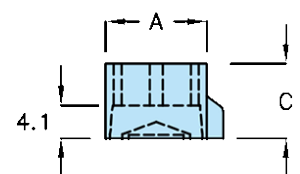
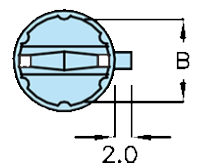

Capacitor Spacer

E-CAP Spacer p.2

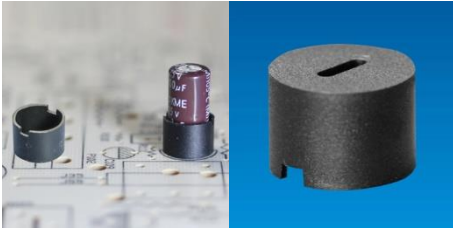

Material: Nylon66
Flame class: 94V-0
Color: Black

PART NO	A	B
ECS-004	Ø7.9	5.5

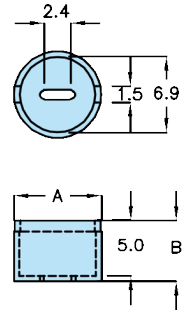

E-CAP Spacer p.3.5



Material: Nylon66
Flame class: 94V-0
Color: Natural

PART NO
ECS-005

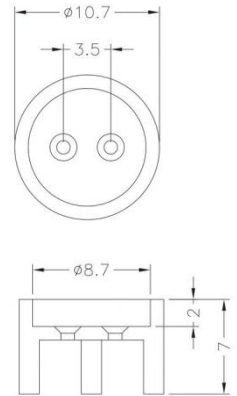

E-CAP Spacer p.10

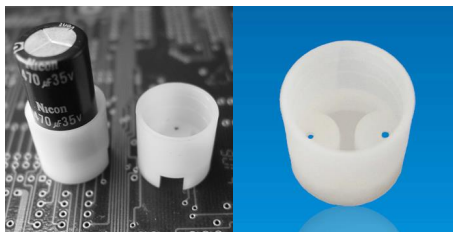

Material: Nylon66
Flame class: 94V-2
Color: Natural

PART NO	A	C
ECS-006	Ø16.0	16.0

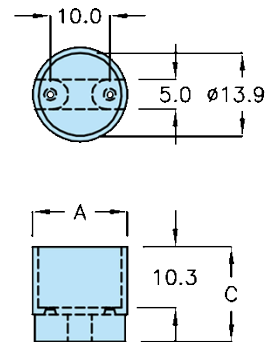

E-CAP Spacer 30° p.10



Material: Nylon66
Flame class: 94V-0
Color: Black/ Natural

PART NO
ECS-007

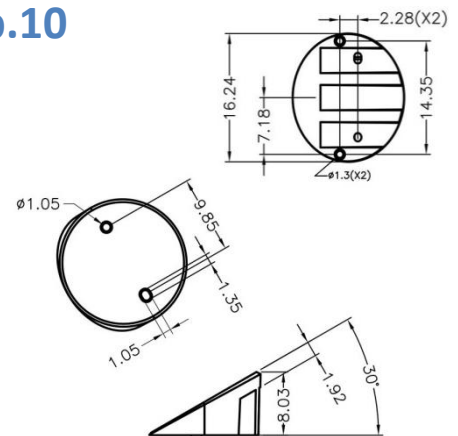

HEADQUARTER

wittig ELECTRONIC GmbH

Gewerbegebiet Süd Nr. 5
D-09618 Brand-Erbisdorf

☎ +49 037322 5280-0

✉ info@wittig-electronic.de
www.wittig-electronic.de

SUBSIDIARY SOUTH-EAST-EUROPE

wittig ELECTRONIC s.r.o.

Prumyslová 2151/4
CZ-68001 Boskovice

☎ +420 515 550-805

✉ wittig@wittig-electronic.cz
www.wittig-electronic.cz

TaylorMade
Solutions

are welcome!