

NPCAP™-PMA Series

- The new construction provides a low profile and high CV.
- Super low ESR, impedance, and high heat resistance characteristics have been secured by using highly conductive polymer electrolytic materials.
- Compatible with digitalization and high frequencies of electrical equipment with superior noise absorption.
- Excellent ESR characteristics, high ripple current, 5,000 hours at 105°C.
- Low-profile product lineup
- Outer coating: Flame-retardant epoxy resin UL94 V-0 or equivalent
- Non-solvent resistant type
- RoHS2 Compliant
- Halogen free products
- This product can't be used for applications related to human life (such as in-vehicle equipment).



◆ SPECIFICATIONS

Items	Characteristics										
Category											
Temperature Range	-55 to +105°C										
Rated Voltage Range	6.3 to 25V _{dc}										
Capacitance Tolerance	±20% (M) (at 20°C, 120Hz)										
Surge Voltage	Rated voltage(V) × 1.15 (at 105°C)										
Leakage Current	Shall not exceed values shown in STANDARD RATINGS. (at 20°C after 2 minutes)										
Dissipation Factor (tan δ)	0.12 max. (at 20°C, 120Hz)										
Low Temperature Characteristics (Max. Impedance Ratio)	Z(-25°C) / Z(+20°C) ≤ 1.15 Z(-55°C) / Z(+20°C) ≤ 1.25 (at 100kHz)										
Endurance	The following specifications shall be satisfied when the capacitors are restored to 20°C after the rated voltage is applied for 5,000 hours at 105°C.										
	<table border="1"> <tr> <td>Appearance</td> <td>No significant damage</td> </tr> <tr> <td>Capacitance change</td> <td>≤ ±20% of the initial value</td> </tr> <tr> <td>D.F. (tan δ)</td> <td>≤ 200% of the initial specified value</td> </tr> <tr> <td>ESR</td> <td>≤ 200% of the initial specified value</td> </tr> <tr> <td>Leakage current</td> <td>≤ The initial specified value</td> </tr> </table>	Appearance	No significant damage	Capacitance change	≤ ±20% of the initial value	D.F. (tan δ)	≤ 200% of the initial specified value	ESR	≤ 200% of the initial specified value	Leakage current	≤ The initial specified value
Appearance	No significant damage										
Capacitance change	≤ ±20% of the initial value										
D.F. (tan δ)	≤ 200% of the initial specified value										
ESR	≤ 200% of the initial specified value										
Leakage current	≤ The initial specified value										
Damp Heat (Steady State)	The following specifications shall be satisfied when the capacitors are restored to 20°C after exposing them for 500 hours at 60°C, 90 to 95% RH without voltage applied.										
	<table border="1"> <tr> <td>Appearance</td> <td>No significant damage</td> </tr> <tr> <td>Capacitance change</td> <td>≤ -20 to +40% of the initial value</td> </tr> <tr> <td>D.F. (tan δ)</td> <td>≤ 200% of the initial specified value</td> </tr> <tr> <td>ESR</td> <td>≤ 200% of the initial specified value</td> </tr> <tr> <td>Leakage current</td> <td>≤ The initial specified value</td> </tr> </table>	Appearance	No significant damage	Capacitance change	≤ -20 to +40% of the initial value	D.F. (tan δ)	≤ 200% of the initial specified value	ESR	≤ 200% of the initial specified value	Leakage current	≤ The initial specified value
Appearance	No significant damage										
Capacitance change	≤ -20 to +40% of the initial value										
D.F. (tan δ)	≤ 200% of the initial specified value										
ESR	≤ 200% of the initial specified value										
Leakage current	≤ The initial specified value										
Surge Voltage	The capacitors shall be subjected to 1,000 cycles each consisting of charge with the surge voltage specified at 105°C for 30 seconds through a protective resistor(R=1kΩ)and discharge for 5 minutes 30 seconds.										
	<table border="1"> <tr> <td>Appearance</td> <td>No significant damage</td> </tr> <tr> <td>Capacitance change</td> <td>≤ ±20% of the initial value</td> </tr> <tr> <td>D.F. (tan δ)</td> <td>≤ 200% of the initial specified value</td> </tr> <tr> <td>ESR</td> <td>≤ 200% of the initial specified value</td> </tr> <tr> <td>Leakage current</td> <td>≤ The initial specified value</td> </tr> </table>	Appearance	No significant damage	Capacitance change	≤ ±20% of the initial value	D.F. (tan δ)	≤ 200% of the initial specified value	ESR	≤ 200% of the initial specified value	Leakage current	≤ The initial specified value
Appearance	No significant damage										
Capacitance change	≤ ±20% of the initial value										
D.F. (tan δ)	≤ 200% of the initial specified value										
ESR	≤ 200% of the initial specified value										
Leakage current	≤ The initial specified value										
Failure Rate	0.5% per 1,000 hours maximum (Confidence level 60% at 105°C)										

*Note : If any doubt arises, measure the leakage current after the following voltage treatment.
Voltage treatment : DC rated voltage is applied to the capacitors for 120 minutes at 105°C.

◆ DIMENSIONS [mm]

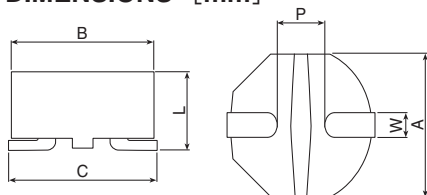

Size Code	A	B	C	L	W	P
F30	7.0±0.1	7.0±0.1	7.2±0.2	3.0max.	1.2±0.2	2.65±0.2

◆ MARKING

EX) 25V22μF



● Rated voltage symbol

Rated voltage(V _{dc})	6.3	16	20	25
Symbol	j	C	D	E

● Capacitance symbol
Capacitance code (ex. 22μF:220)

NPCAP™-PMA Series

◆ PART NUMBERING SYSTEM

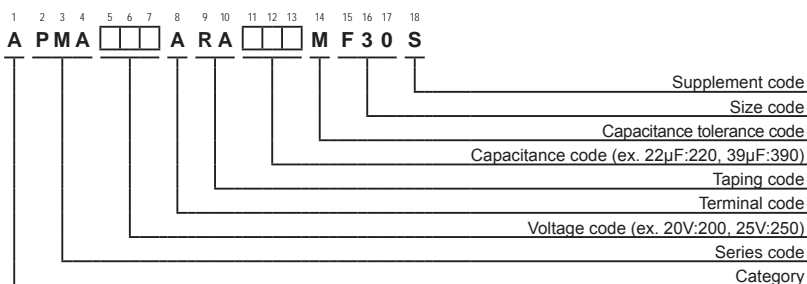

◆ STANDARD RATINGS

WV (V _{dc})	Cap (μF)	Size code	Leakage current (μA max./ after 2min.)	ESR (mΩ max./20°C, 100k to 300kHz)	Rated ripple current (mA rms/105°C, 100kHz)	Part No.
6.3	220	F30	693	35	2,300	APMA6R3ARA221MF30S
16	56	F30	448	40	2,200	APMA160ARA560MF30S
	68	F30	544	50	2,000	APMA160ARA680MF30S
	100	F30	800	50	2,000	APMA160ARA101MF30S
20	39	F30	390	45	2,100	APMA200ARA390MF30S
	47	F30	470	50	2,000	APMA200ARA470MF30S
	68	F30	680	50	2,000	APMA200ARA680MF30S
25	22	F30	275	50	2,000	APMA250ARA220MF30S
	33	F30	412	50	2,000	APMA250ARA330MF30S
	47	F30	587	50	2,000	APMA250ARA470MF30S

◆ RATED RIPPLE CURRENT MULTIPLIERS

● Frequency Multipliers

Frequency (Hz)	120	1k	10k	50k	100k to 500k
SMD type	0.05	0.30	0.55	0.70	1.00

◆ RECOMMENDED REFLOW SOLDERING CONDITIONS

● Reflow Profile

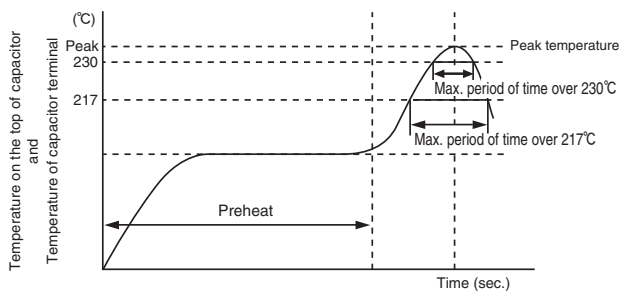

Voltage range (V _{dc})	Preheat	Time maintained above 217°C	Time maintained above 230°C	Peak temp.	Reflow number
6.3 to 25V	150 to 180°C	50 sec. max.	40 sec. max.	260°C max.	1-cycle only
	120 sec. max.	40 sec. max.	30 sec. max.		2-cycles allowed

● Recommended Solder Land on PC Board [mm]

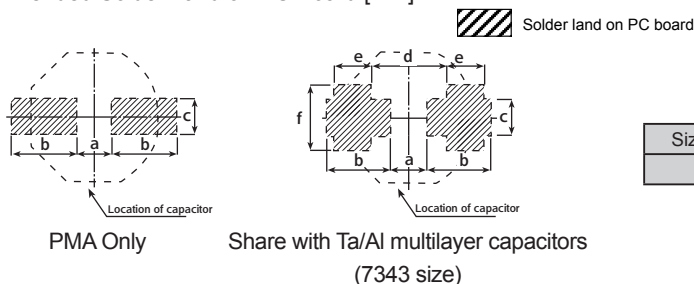

Size code	a	b	c	d	e	f
F30	1.9	3.5	2.0	4.0	2.0	3.0

Product specifications in this bulletin are subject to change without notice. Request our product specifications before purchase and/or use. Please use our products based on the information contained in this bulletin and product specifications. Please contact us for mass production schedule.

NPCAP™-PMA Series

◆ CARRIER TAPE [mm]

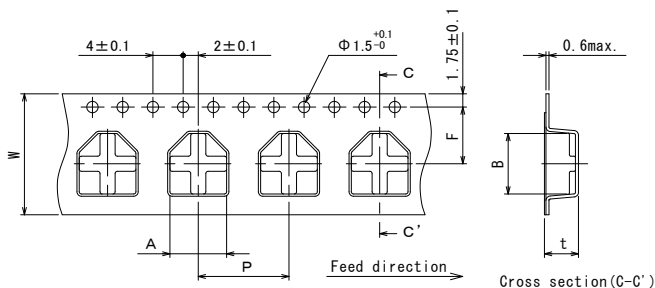

[mm]

Items	W	A	B	F	P	t
Size Code	± 0.3	± 0.2	± 0.2	± 0.1	± 0.1	± 0.2
F30	16.0	7.5	8.0	7.5	12.0	3.7

◆ REEL DIMENSIONS [mm]

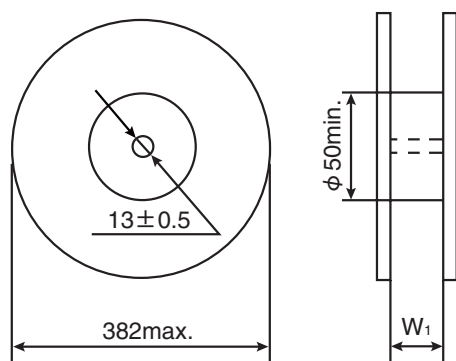

◆ POLARITY

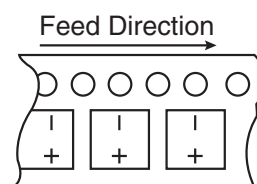

Size Code	Quantity (pcs./reel)	Quantity (pcs./box)	W ₁ (mm)
F30	1,000	7,000	18

◆ Storage

Store PMA series capacitors in a cool, dry place. Store at a temperature between 5 and 35 °C , with a humidity of 75%RH or less. PMA series capacitors are sealed in a special laminated aluminum bag. Use all capacitors once the bag is opened. Return unused capacitors to the bag, and seal it with a zipper. Please refer to the following storage conditions.

- Maximum storage term before the bag is opened : Within 2 years after manufacturing
- Maximum storage condition after the bag is opened : Within 7 days after the bag is opened