

Please read this notice before using the TAIYO YUDEN products.

REMINDERS

- Product information in this catalog is as of October 2017. All of the contents specified herein are subject to change without notice due to technical improvements, etc. Therefore, please check for the latest information carefully before practical application or use of our products.

Please note that TAIYO YUDEN shall not be in any way responsible for any damages and defects in products or equipment incorporating our products, which are caused under the conditions other than those specified in this catalog or individual product specification sheets.

- Please contact TAIYO YUDEN for further details of product specifications as the individual product specification sheets are available.
- Please conduct validation and verification of our products in actual condition of mounting and operating environment before using our products.
- The products listed in this catalog are intended for use in general electronic equipment (e.g., AV equipment, OA equipment, home electric appliances, office equipment, information and communication equipment including, without limitation, mobile phone, and PC) and medical equipment classified as Class I or II by IMDRF. Please be sure to contact TAIYO YUDEN for further information before using the products for any equipment which may directly cause loss of human life or bodily injury (e.g., transportation equipment including, without limitation, automotive powertrain control system, train control system, and ship control system, traffic signal equipment, disaster prevention equipment, medical equipment classified as Class III by IMDRF, highly public information network equipment including, without limitation, telephone exchange, and base station).

Please do not incorporate our products into any equipment requiring high levels of safety and/or reliability (e.g., aerospace equipment, aviation equipment*, medical equipment classified as Class IV by IMDRF, nuclear control equipment, undersea equipment, military equipment).

*Note: There is a possibility that our products can be used only for aviation equipment that does not directly affect the safe operation of aircraft (e.g., in-flight entertainment, cabin light, electric seat, cooking equipment) if such use meets requirements specified separately by TAIYO YUDEN. Please be sure to contact TAIYO YUDEN for further information before using our products for such aviation equipment.

When our products are used even for high safety and/or reliability-required devices or circuits of general electronic equipment, it is strongly recommended to perform a thorough safety evaluation prior to use of our products and to install a protection circuit as necessary.

Please note that unless you obtain prior written consent of TAIYO YUDEN, TAIYO YUDEN shall not be in any way responsible for any damages incurred by you or third parties arising from use of the products listed in this catalog for any equipment requiring inquiry to TAIYO YUDEN or prohibited for use by TAIYO YUDEN as described above.

- Information contained in this catalog is intended to convey examples of typical performances and/or applications of our products and is not intended to make any warranty with respect to the intellectual property rights or any other related rights of TAIYO YUDEN or any third parties nor grant any license under such rights.
- Please note that the scope of warranty for our products is limited to the delivered our products themselves and TAIYO YUDEN shall not be in any way responsible for any damages resulting from a fault or defect in our products. Notwithstanding the foregoing, if there is a written agreement (e.g., supply and purchase agreement, quality assurance agreement) signed by TAIYO YUDEN and your company, TAIYO YUDEN will warrant our products in accordance with such agreement.
- The contents of this catalog are applicable to our products which are purchased from our sales offices or authorized distributors (hereinafter "TAIYO YUDEN's official sales channel"). Please note that the contents of this catalog are not applicable to our products purchased from any seller other than TAIYO YUDEN's official sales channel.
- Caution for Export
Some of our products listed in this catalog may require specific procedures for export according to "U.S. Export Administration Regulations", "Foreign Exchange and Foreign Trade Control Law" of Japan, and other applicable regulations. Should you have any questions on this matter, please contact our sales staff.

MULTILAYER CERAMIC CAPACITORS

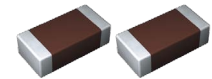

WAVE

REFLOW

PARTS NUMBER

J	M	K	3	1	6	△	B	J	1	0	6	M	L	-	T	△
①	②	③	④	⑤	⑥	⑦	⑧	⑨	⑩	⑪	⑫					

△=Blank space

① Rated voltage

Code	Rated voltage [VDC]
P	2.5
A	4
J	6.3
L	10
E	16
T	25
G	35
U	50
H	100
Q	250
S	630

③ End termination

Code	End termination
K	Plated
S	Cu Internal Electrodes

② Series name

Code	Series name
M	Multilayer ceramic capacitor
V	Multilayer ceramic capacitor for high frequency
W	LW reverse type multilayer capacitor

④ Dimension (L × W)

Type	Dimensions (L × W) [mm]	EIA (inch)
021	0.25 × 0.125	008004
042	0.4 × 0.2	01005
063	0.6 × 0.3	0201
105	1.0 × 0.5	0402
	0.52 × 1.0 ※	0204
107	1.6 × 0.8	0603
	0.8 × 1.6 ※	0306
212	2.0 × 1.25	0805
	1.25 × 2.0 ※	0508
316	3.2 × 1.6	1206
325	3.2 × 2.5	1210
432	4.5 × 3.2	1812

Note : ※LW reverse type (□WK) only

⑤ Dimension tolerance

Code	Type	L [mm]	W [mm]	T [mm]
△	ALL	Standard	Standard	Standard
A	063	0.6±0.05	0.3±0.05	0.3±0.05
	105	1.0±0.10	0.5±0.10	0.5±0.10
	107	1.6+0.15/-0.05	0.8+0.15/-0.05	0.8+0.15/-0.05
	212	2.0+0.15/-0.05	1.25+0.15/-0.05	0.45±0.05
				0.85±0.10
				1.25+0.15/-0.05
316	3.2±0.20	1.6±0.20	0.85±0.10	
325	3.2±0.30	2.5±0.30	1.6±0.20	
B	063	0.6±0.09	0.3±0.09	2.5±0.30
	105	1.0+0.15/-0.05	0.5+0.15/-0.05	0.3±0.09
				0.5+0.15/-0.05
	107	1.6+0.20/-0	0.8+0.20/-0	0.45±0.05
	212	2.0+0.20/-0	1.25+0.20/-0	0.8+0.20/-0
0.45±0.05				
316	3.2±0.30	1.6±0.30	0.85±0.10	
C	105	1.0+0.20/-0	0.5+0.20/-0	1.25+0.20/-0
				1.6±0.30

Note: cf. STANDARD EXTERNAL DIMENSIONS

△= Blank space

⑥ Temperature characteristics code

■ High dielectric type (Excluding Super low distortion multilayer ceramic capacitor)

Code	Applicable standard	Temperature range [°C]	Ref. Temp. [°C]	Capacitance change	Capacitance tolerance	Tolerance code
BJ	JIS	B	-25~+85	20	±10%	K
						M
	EIA	X5R	-55~+85	25	±15%	K
B7	EIA	X7R	-55~+125	25	±15%	M
						K
C6	EIA	X6S	-55~+105	25	±22%	K
						M
C7	EIA	X7S	-55~+125	25	±22%	K
						M
LD(※)	EIA	X5R	-55~+85	25	±15%	K
						M

Note : ※LD Low distortion high value multilayer ceramic capacitor

△= Blank space

▶ This catalog contains the typical specification only due to the limitation of space. When you consider the purchase of our products, please check our product specification sheets. For details of each product (characteristics graph, reliability information, precautions for use, and so on), see our website (<http://www.ty-top.com/>).

■ Temperature compensating type

Code	Applicable standard		Temperature range [°C]	Ref. Temp. [°C]	Capacitance change	Capacitance tolerance	Tolerance code	
CG	EIA	C0G	-55 ~ +125	25	0 ± 30ppm/°C	±0.05pF	A	
						±0.1pF	B	
						±0.25pF	C	
						±0.5pF	D	
						±5%	J	
UJ	JIS	UJ	-55 ~ +125	20	-750 ± 120ppm/°C	±0.25pF	C	
	EIA	U2J				25	±0.5pF	D
							±5%	J
UK	JIS	UK	-55 ~ +125	20	-750 ± 250ppm/°C	±0.25pF	C	
	EIA	U2K	-55 ~ +125	25				
SL	JIS	SL	-55 ~ +125	20	+350 ~ -1000ppm/°C	±5%	J	

⑥ Series code

• Super low distortion multilayer ceramic capacitor

Code	Series code
SD	Standard

• Medium-High Voltage Multilayer Ceramic Capacitor

Code	Series code
SD	Standard

⑦ Nominal capacitance

Code (example)	Nominal capacitance
0R5	0.5pF
010	1pF
100	10pF
101	100pF
102	1,000pF
103	10,000pF
104	0.1 μF
105	1.0 μF
106	10 μF
107	100 μF

Note : R=Decimal point

⑧ Capacitance tolerance

Code	Capacitance tolerance
A	±0.05pF
B	±0.1pF
C	±0.25pF
D	±0.5pF
F	±1pF
G	±2%
J	±5%
K	±10%
M	±20%
Z	+80/-20%

⑨ Thickness

Code	Thickness [mm]
K	0.125
H	0.13
E	0.18
C	0.2
D	
P	0.3
T	
K	0.45 (107type or more)
V	0.5
W	
A	0.8
D	0.85 (212type or more)
F	1.15
G	1.25
L	1.6
N	1.9
Y	2.0 max
M	2.5

⑩ Special code

Code	Special code
-	Standard

⑪ Packaging

Code	Packaging
F	φ178mm Taping (2mm pitch)
T	φ178mm Taping (4mm pitch)
P	φ178mm Taping (4mm pitch, 1000 pcs/reel) 325 type (Thickness code M)
R	φ178mm Taping (2mm pitch) 105type only (Thickness code E,H)
W	φ178mm Taping (1mm pitch) 021/042type only

⑫ Internal code

Code	Internal code
△	Standard

► This catalog contains the typical specification only due to the limitation of space. When you consider the purchase of our products, please check our product specification sheets. For details of each product (characteristics graph, reliability information, precautions for use, and so on), see our website (<http://www.ty-top.com/>).

■ STANDARD EXTERNAL DIMENSIONS

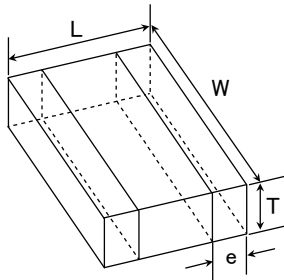
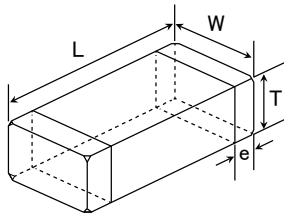

※ LW reverse type

Type(EIA)	Dimension [mm]					
	L	W	T	*1	e	
□MK021(008004)	0.25±0.013	0.125±0.013	0.125±0.013	K	0.0675±0.0275	
□VS021(008004)	0.25±0.013	0.125±0.013	0.125±0.013	K	0.0675±0.0275	
□MK042(01005)	0.4±0.02	0.2±0.02	0.2±0.02	C	0.1±0.03	
□VS042(01005)				D		
□MK063(0201)	0.6±0.03	0.3±0.03	0.3±0.03	P	0.15±0.05	
□MK105(0402)				T		
□MK105(0402)	1.0±0.05	0.5±0.05	0.5±0.05	0.13±0.02	H	0.25±0.10
				0.18±0.02	E	
				0.2±0.02	C	
				0.3±0.03	P	
				0.5±0.05	V	
□VK105(0402)	1.0±0.05	0.5±0.05	0.5±0.05	W	0.25±0.10	
□WK105(0204)※	0.52±0.05	1.0±0.05	0.3±0.05	P	0.18±0.08	
□MK107(0603)	1.6±0.10	0.8±0.10	0.8±0.10	0.45±0.05	K	0.35±0.25
				0.8±0.10	A	
□WK107(0306)※	0.8±0.10	1.6±0.10	0.5±0.05	0.45±0.05	V	0.25±0.15
				0.85±0.10	K	
□MK212(0805)	2.0±0.10	1.25±0.10	1.25±0.10	0.85±0.10	D	0.5±0.25
				1.25±0.10	G	
				0.85±0.10	D	
□WK212(0508)※	1.25±0.15	2.0±0.15	0.85±0.10	0.85±0.10	D	0.3±0.2
				1.15±0.10	F	
				1.6±0.20	L	
□MK316(1206)	3.2±0.15	1.6±0.15	0.85±0.10	0.85±0.10	D	0.5+0.35/-0.25
				1.15±0.10	F	
				1.9±0.20	N	
				1.9+0.1/-0.2	Y	
□MK325(1210)	3.2±0.30	2.5±0.20	2.5±0.20	2.5±0.20	M	0.6±0.3
				0.85±0.10	D	
				1.15±0.10	F	
				1.9±0.20	N	
				1.9+0.1/-0.2	Y	
□MK432(1812)	4.5±0.40	3.2±0.30	2.5±0.20	M	0.9±0.6	

Note : ※. LW reverse type, *1.Thickness code

■ STANDARD QUANTITY

Type	EIA (inch)	Dimension		Standard quantity [pcs]		
		[mm]	Code	Paper tape	Embossed tape	
021	008004	0.125	K	—	50000	
042	01005	0.2	C	—	40000	
			D			
063	0201	0.3	P	15000	—	
			T			
105	0402	0.13	H	—	20000	
			E	—	15000	
			C	20000	—	
			P	15000	—	
			V	10000	—	
	W	—				
0204 ※	0.30	P	—	—		
107	0603	0.45	K	4000	—	
			A			
	0306 ※	0.50	V	—	4000	
212	0805	0.85	K	4000	—	
			D			
			G			
	0508 ※	0.85	D	4000	—	
316	1206	0.85	D	4000	—	
			F			
			L			
325	1210	0.85	D	—	2000	
			F			
			N			
			2.0 max			Y
			2.5			M
432	1812	2.5	M	—	500	

Note : ※.LW Reverse type(□WK)

▶ This catalog contains the typical specification only due to the limitation of space. When you consider the purchase of our products, please check our product specification sheets. For details of each product (characteristics graph, reliability information, precautions for use, and so on), see our website (<http://www.ty-top.com/>).

Super Low Distortion Multilayer Ceramic Capacitors

● 105TYPE

【Temperature Characteristic SD : Standard】 0.5mm thickness (V)

Part number 1	Part number 2	Rated voltage [V]	Temperature characteristics	Capacitance [F]	Capacitance tolerance [%]	tan δ [%]	HTLT		Soldering R:Reflow W:Wave
							Rated voltage x %	Thickness ^{*3} [mm]	
UMK105 SD391KV-F		50	Standard Type	390 p	±10	0.1	200	0.5±0.05	R
UMK105 SD471KV-F				470 p	±10	0.1	200	0.5±0.05	R
UMK105 SD561KV-F				560 p	±10	0.1	200	0.5±0.05	R
TMK105 SD681KV-F		25		680 p	±10	0.1	200	0.5±0.05	R
TMK105 SD821KV-F				820 p	±10	0.1	200	0.5±0.05	R
TMK105 SD102KV-F				1000 p	±10	0.1	200	0.5±0.05	R
TMK105 SD122KV-F		16		1200 p	±10	0.1	200	0.5±0.05	R
EMK105 SD152KV-F				1500 p	±10	0.1	200	0.5±0.05	R
EMK105 SD182KV-F				1800 p	±10	0.1	200	0.5±0.05	R
EMK105 SD222KV-F		10		2200 p	±10	0.1	200	0.5±0.05	R
EMK105 SD272KV-F				2700 p	±10	0.1	200	0.5±0.05	R
LMK105 SD332KV-F				3300 p	±10	0.1	200	0.5±0.05	R
LMK105 SD392KV-F		10	3900 p	±10	0.1	200	0.5±0.05	R	
LMK105 SD472KV-F			4700 p	±10	0.1	200	0.5±0.05	R	

【Temperature Characteristic SD : Standard】 0.3mm thickness (P)

Part number 1	Part number 2	Rated voltage [V]	Temperature characteristics	Capacitance [F]	Capacitance tolerance [%]	tan δ [%]	HTLT		Soldering R:Reflow W:Wave
							Rated voltage x %	Thickness ^{*3} [mm]	
LMK105 SD152KP-F		10	Standard Type	1500 p	±10	0.1	200	0.3±0.03	R
LMK105 SD272KP-F		6.3		2700 p	±10	0.1	200	0.3±0.03	R

● 107TYPE

【Temperature Characteristic SD : Standard】 0.8mm thickness (A)

Part number 1	Part number 2	Rated voltage [V]	Temperature characteristics	Capacitance [F]	Capacitance tolerance [%]	tan δ [%]	HTLT		Soldering R:Reflow W:Wave	
							Rated voltage x %	Thickness ^{*3} [mm]		
UMK107 SD102KA-T		50	Standard Type	1000 p	±10	0.1	200	0.8±0.10	R	
UMK107 SD122KA-T				1200 p	±10	0.1	200	0.8±0.10	R	
UMK107 SD152KA-T				1500 p	±10	0.1	200	0.8±0.10	R	
UMK107 SD182KA-T				1800 p	±10	0.1	200	0.8±0.10	R	
UMK107 SD222KA-T				25	2200 p	±10	0.1	200	0.8±0.10	R
UMK107 SD272KA-T					2700 p	±10	0.1	200	0.8±0.10	R
UMK107 SD332KA-T					3300 p	±10	0.1	200	0.8±0.10	R
TMK107 SD392KA-T		16		3900 p	±10	0.1	200	0.8±0.10	R	
TMK107 SD472KA-T				4700 p	±10	0.1	200	0.8±0.10	R	
EMK107 SD562KA-T				5600 p	±10	0.1	200	0.8±0.10	R	
EMK107 SD682KA-T		10		6800 p	±10	0.1	200	0.8±0.10	R	
EMK107 SD822KA-T				8200 p	±10	0.1	200	0.8±0.10	R	
EMK107 SD103KA-T				0.01 μ	±10	0.1	200	0.8±0.10	R	
LMK107 SD123KA-T		10		0.012 μ	±10	0.1	200	0.8±0.10	R	
LMK107 SD153KA-T			0.015 μ	±10	0.1	200	0.8±0.10	R		
LMK107 SD183KA-T			0.018 μ	±10	0.1	200	0.8±0.10	R		
LMK107 SD223KA-T			0.022 μ	±10	0.1	200	0.8±0.10	R		

● 212TYPE

【Temperature Characteristic SD : Standard】 1.25mm thickness (G)

Part number 1	Part number 2	Rated voltage [V]	Temperature characteristics	Capacitance [F]	Capacitance tolerance [%]	tan δ [%]	HTLT		Soldering R:Reflow W:Wave
							Rated voltage x %	Thickness ^{*3} [mm]	
GMK212 SD183KG-T		35	Standard Type	0.018 μ	±10	0.1	200	1.25±0.10	R
GMK212 SD223KG-T				0.022 μ	±10	0.1	200	1.25±0.10	R
GMK212 SD273KG-T				0.027 μ	±10	0.1	200	1.25±0.10	R
LMK212 SD683KG-T		10		0.068 μ	±10	0.1	200	1.25±0.10	R
LMK212 SD823KG-T				0.082 μ	±10	0.1	200	1.25±0.10	R
LMK212 SD104KG-T				0.1 μ	±10	0.1	200	1.25±0.10	R

【Temperature Characteristic SD : Standard】 0.85mm thickness (D)

Part number 1	Part number 2	Rated voltage [V]	Temperature characteristics	Capacitance [F]	Capacitance tolerance [%]	tan δ [%]	HTLT		Soldering R:Reflow W:Wave	
							Rated voltage x %	Thickness ^{*3} [mm]		
UMK212 SD392KD-T		50	Standard Type	3900 p	±10	0.1	200	0.85±0.10	R	
UMK212 SD472KD-T				4700 p	±10	0.1	200	0.85±0.10	R	
UMK212 SD562KD-T				5600 p	±10	0.1	200	0.85±0.10	R	
UMK212 SD682KD-T				6800 p	±10	0.1	200	0.85±0.10	R	
UMK212 SD822KD-T				35	8200 p	±10	0.1	200	0.85±0.10	R
UMK212 SD103KD-T					0.01 μ	±10	0.1	200	0.85±0.10	R
GMK212 SD123KD-T		16		0.012 μ	±10	0.1	200	0.85±0.10	R	
GMK212 SD153KD-T				0.015 μ	±10	0.1	200	0.85±0.10	R	
EMK212 SD333KD-T				0.033 μ	±10	0.1	200	0.85±0.10	R	
LMK212 SD473KD-T		10		0.047 μ	±10	0.1	200	0.85±0.10	R	

● 316TYPE

【Temperature Characteristic SD : Standard】 1.6mm thickness (L)

Part number 1	Part number 2	Rated voltage [V]	Temperature characteristics	Capacitance [F]	Capacitance tolerance [%]	tan δ [%]	HTLT		Soldering R:Reflow W:Wave
							Rated voltage x %	Thickness ^{*3} [mm]	
TMK316 SD823KL-T		25	Standard Type	0.082 μ	±10	0.1	200	1.6±0.20	R
TMK316 SD104KL-T				0.1 μ	±10	0.1	200	1.6±0.20	R

【Temperature Characteristic SD : Standard】 1.15mm thickness (F)

Part number 1	Part number 2	Rated voltage [V]	Temperature characteristics	Capacitance [F]	Capacitance tolerance [%]	tan δ [%]	HTLT	Thickness* ³ [mm]	Soldering R:Reflow W:Wave
							Rated voltage x %		
GMK316 SD333KF-T		35	Standard Type	0.033 μ	± 10	0.1	200	1.15 \pm 0.10	R
GMK316 SD393KF-T				0.039 μ	± 10	0.1	200	1.15 \pm 0.10	R
TMK316 SD473KF-T				0.047 μ	± 10	0.1	200	1.15 \pm 0.10	R
TMK316 SD563KF-T		25		0.056 μ	± 10	0.1	200	1.15 \pm 0.10	R
TMK316 SD683KF-T				0.068 μ	± 10	0.1	200	1.15 \pm 0.10	R

Low Distortion High Value Multilayer Ceramic Capacitors(CF LD)

● 107TYPE

【Temperature Characteristic LD : X5R】 0.8mm thickness (A)

Part number 1	Part number 2	Rated voltage [V]	Temperature characteristics	Capacitance [F]	Capacitance tolerance [%]	tan δ [%]	HTLT	Thickness* ³ [mm]	Soldering R:Reflow W:Wave
							Rated voltage x %		
UMK107BLD224[A-T]		50	X5R	0.22 μ	$\pm 10, \pm 20$	10	150	0.8+0.20/-0	R
TMK107BLD474[A-T]		25	X5R	0.47 μ	$\pm 10, \pm 20$	10	150	0.8+0.20/-0	R
TMK107BLD105[A-T]			X5R	1 μ	$\pm 10, \pm 20$	10	150	0.8+0.20/-0	R

● 212TYPE

【Temperature Characteristic LD : X5R】 1.25mm thickness (G)

Part number 1	Part number 2	Rated voltage [V]	Temperature characteristics	Capacitance [F]	Capacitance tolerance [%]	tan δ [%]	HTLT	Thickness* ³ [mm]	Soldering R:Reflow W:Wave
							Rated voltage x %		
GMK212 LD105[G-T]		35	X5R	1 μ	$\pm 10, \pm 20$	10	150	1.25 \pm 0.10	R
GMK212BLD225[G-T]			X5R	2.2 μ	$\pm 10, \pm 20$	10	150	1.25+0.20/-0	R

● 316TYPE

【Temperature Characteristic LD : X5R】 1.6mm thickness (L)

Part number 1	Part number 2	Rated voltage [V]	Temperature characteristics	Capacitance [F]	Capacitance tolerance [%]	tan δ [%]	HTLT	Thickness* ³ [mm]	Soldering R:Reflow W:Wave
							Rated voltage x %		
UMK316 LD105[L-T]		50	X5R	1 μ	$\pm 10, \pm 20$	10	150	1.6 \pm 0.20	R
GMK316BLD475[L-T]		35	X5R	4.7 μ	$\pm 10, \pm 20$	10	150	1.6 \pm 0.30	R
TMK316BLD106[L-T]		25	X5R	10 μ	$\pm 10, \pm 20$	10	150	1.6 \pm 0.30	R

● 325TYPE

【Temperature Characteristic LD : X5R】 1.9mm thickness (N)

Part number 1	Part number 2	Rated voltage [V]	Temperature characteristics	Capacitance [F]	Capacitance tolerance [%]	tan δ [%]	HTLT	Thickness* ³ [mm]	Soldering R:Reflow W:Wave
							Rated voltage x %		
UMK325 LD105[N-T]		50	X5R	1 μ	$\pm 10, \pm 20$	10	200	1.9 \pm 0.20	R

【Temperature Characteristic LD : X5R】 2.5mm thickness (M)

Part number 1	Part number 2	Rated voltage [V]	Temperature characteristics	Capacitance [F]	Capacitance tolerance [%]	tan δ [%]	HTLT	Thickness* ³ [mm]	Soldering R:Reflow W:Wave
							Rated voltage x %		
UMK325 LD475[M-P]		50	X5R	4.7 μ	$\pm 10, \pm 20$	10	200	2.5 \pm 0.20	R

► This catalog contains the typical specification only due to the limitation of space. When you consider the purchase of our products, please check our product specification sheets. For details of each product (characteristics graph, reliability information, precautions for use, and so on), see our website (<http://www.ty-top.com/>).

Multilayer Ceramic Capacitors

PACKAGING

① Minimum Quantity

● Taped package

Type(EIA)	Thickness		Standard quantity [pcs]	
	mm	code	Paper tape	Embossed tape
<input type="checkbox"/> MK021(008004)	0.125	K	—	50000
<input type="checkbox"/> VS021(008004)				
<input type="checkbox"/> MK042(01005)	0.2	C, D	—	40000
<input type="checkbox"/> VS042(01005)				
<input type="checkbox"/> MK063(0201)	0.3	P,T	15000	—
<input type="checkbox"/> WK105(0204) ※	0.3	P	10000	—
<input type="checkbox"/> MK105(0402) <input type="checkbox"/> MF105(0402)	0.13	H	—	20000
	0.18	E	—	15000
	0.2	C	20000	—
	0.3	P	15000	—
	0.5	V	10000	—
<input type="checkbox"/> VK105(0402)	0.5	W	10000	—
<input type="checkbox"/> MK107(0603)	0.45	K	4000	—
<input type="checkbox"/> WK107(0306) ※	0.5	V	—	4000
<input type="checkbox"/> MF107(0603)	0.8	A	4000	—
<input type="checkbox"/> VS107(0603)	0.7	C	4000	—
<input type="checkbox"/> MJ107(0603)	0.8	A	3000	3000
<input type="checkbox"/> MK212(0805)	0.45	K	4000	—
<input type="checkbox"/> WK212(0508) ※	0.85	D		
<input type="checkbox"/> MF212(0805)	1.25	G	—	3000
<input type="checkbox"/> VS212(0805)	0.85	D	4000	—
<input type="checkbox"/> MJ212(0805)	0.85	D	4000	—
	1.25	G	—	2000
<input type="checkbox"/> MK316(1206) <input type="checkbox"/> MF316(1206)	0.85	D	4000	—
	1.15	F	—	3000
	1.6	L	—	2000
<input type="checkbox"/> MJ316(1206)	1.15	F	—	3000
	1.6	L	—	2000
<input type="checkbox"/> MK325(1210) <input type="checkbox"/> MF325(1210)	0.85	D	—	2000
	1.15	F		
	1.9	N		
	2.0max.	Y		
<input type="checkbox"/> MJ325(1210)	2.5	M	—	1000
	1.9	N	—	2000
	2.5	M	—	500(T), 1000(P)
<input type="checkbox"/> MK432(1812)	2.5	M	—	500

Note : ※ LW Reverse type.

② Taping material

※No bottom tape for pressed carrier tape

● Card board carrier tape

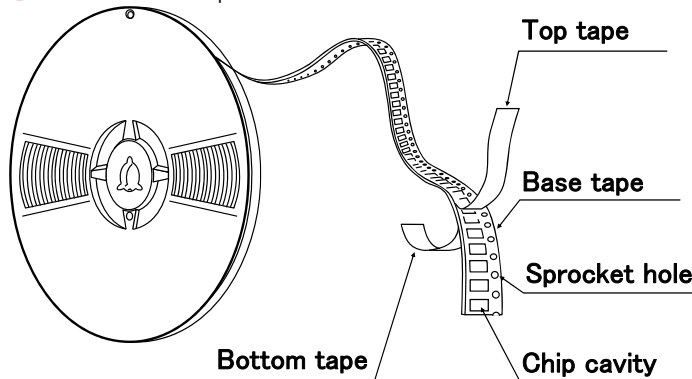

● Embossed tape

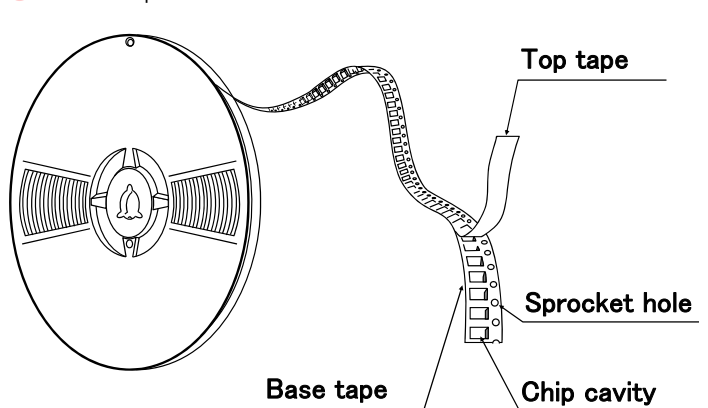

▶ This catalog contains the typical specification only due to the limitation of space. When you consider the purchase of our products, please check our specification. For details of each product (characteristics graph, reliability information, precautions for use, and so on), see our Web site (<http://www.ty-top.com/>).

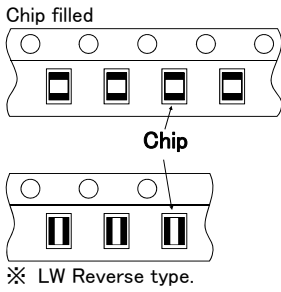

③ Representative taping dimensions

● Paper Tape (8mm wide)

● Pressed carrier tape (2mm pitch)

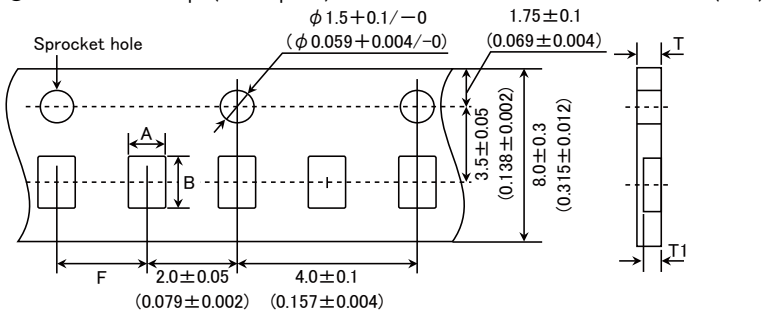

Type(EIA)	Chip Cavity		Insertion Pitch F	Tape Thickness	
	A	B		T	T1
□MK063(0201)	0.37	0.67	2.0±0.05	0.45max.	0.42max.
□WK105(0204) ※	0.65	1.15		0.4max.	0.3max.
□MK105(0402) (*1 C)				0.45max.	0.42max.
□MK105(0402) (*1 P)					

Note *1 Thickness, C: 0.2mm ,P: 0.3mm. ※ LW Reverse type.

Unit: mm

● Punched carrier tape (2mm pitch)

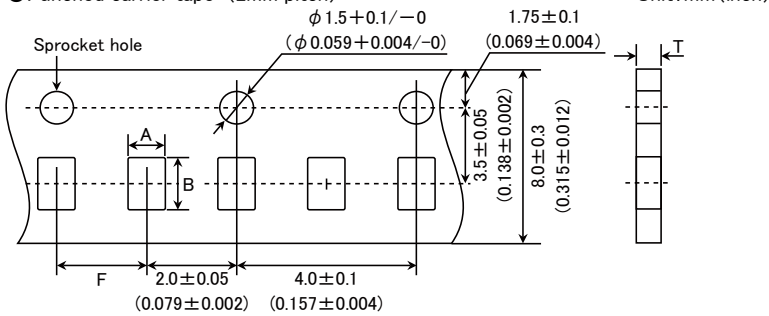

Type(EIA)	Chip Cavity		Insertion Pitch F	Tape Thickness
	A	B		T
□MK105 (0402)	0.65	1.15	2.0±0.05	0.8max.
□MF105 (0402)				
□VK105 (0402)				

Unit: mm

● Punched carrier tape (4mm pitch)

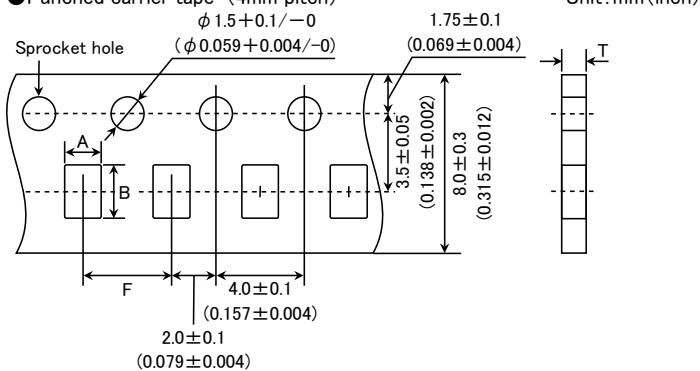

▶ This catalog contains the typical specification only due to the limitation of space. When you consider the purchase of our products, please check our specification. For details of each product (characteristics graph, reliability information, precautions for use, and so on), see our Web site (<http://www.ty-top.com/>).

Type(EIA)	Chip Cavity		Insertion Pitch	Tape Thickness	
	A	B		F	T
□MK107(0603) □WK107(0306) ※ □MF107(0603)	1.0	1.8	4.0±0.1	1.1max.	
□MK212(0805) □WK212(0508) ※	1.65	2.4		1.1max.	
□MK316(1206)	2.0	3.6			

Note: Taping size might be different depending on the size of the product. ※ LW Reverse type.

Unit: mm

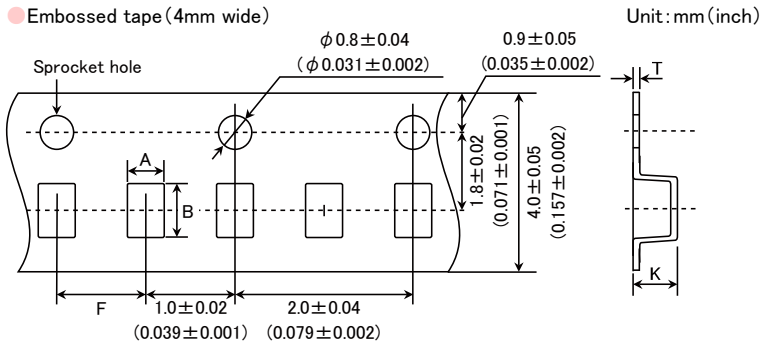

Type(EIA)	Chip Cavity		Insertion Pitch	Tape Thickness	
	A	B		K	T
□MK021(008004) □VS021(008004)	0.135	0.27	1.0±0.02	0.5max.	0.25max.
□MK042(01005) □VS042(01005)					

Unit: mm

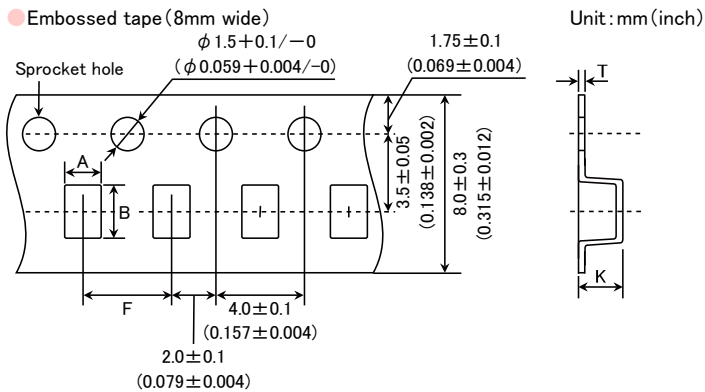

Type(EIA)	Chip Cavity		Insertion Pitch	Tape Thickness	
	A	B		K	T
□MK105(0402)	0.6	1.1	2.0±0.1	0.6max.	0.2±0.1
□WK107(0306) ※ □MK212(0805) □MF212(0805)	1.0	1.8	4.0±0.1	1.3max.	0.25±0.1
□MK316(1206) □MF316(1206)	2.0	3.6		3.4max.	0.6max.
□MK325(1210) □MF325(1210)	2.8	3.6			

Note: ※ LW Reverse type.

Unit: mm

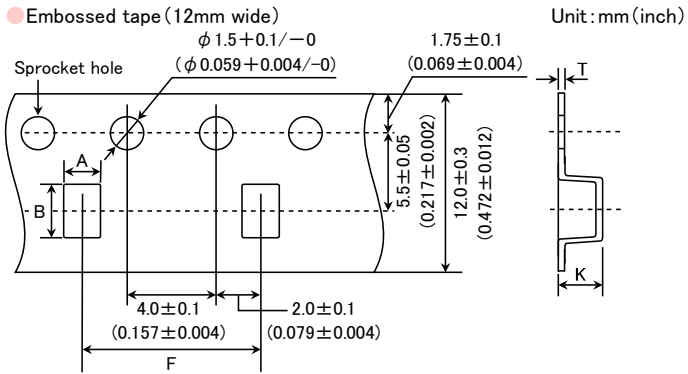

Type(EIA)	Chip Cavity		Insertion Pitch	Tape Thickness	
	A	B	F	K	T
□MK325(1210)	3.1	4.0	8.0±0.1	4.0max.	0.6max.
□MK432(1812)	3.7	4.9	8.0±0.1	4.0max.	0.6max.

Unit: mm

④Trailer and Leader

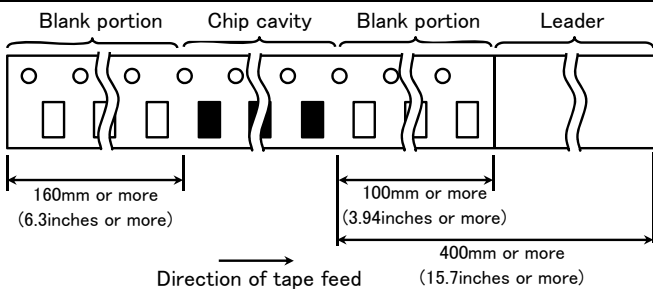

⑤Reel size

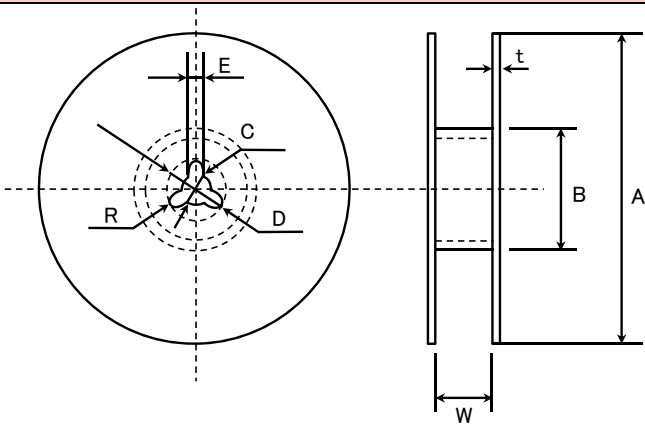

A	B	C	D	E	R
$\phi 178 \pm 2.0$	$\phi 50 \text{ min.}$	$\phi 13.0 \pm 0.2$	$\phi 21.0 \pm 0.8$	2.0 ± 0.5	1.0
	T	W			
4mm wide tape	1.5max.	5 ± 1.0			
8mm wide tape	2.5max.	10 ± 1.5			
12mm wide tape	2.5max.	14 ± 1.5			

Unit: mm

⑥Top Tape Strength

The top tape requires a peel-off force of 0.1 to 0.7N in the direction of the arrow as illustrated below.

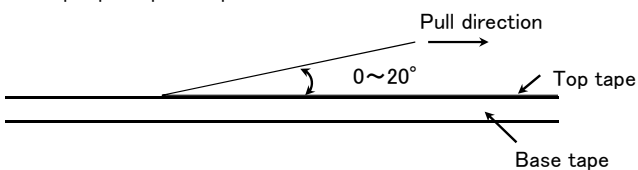

Super Low Distortion Multilayer Ceramic Capacitors

RELIABILITY DATA

1. Operating Temperature Range

Specified Value	-55 to +125°C
-----------------	---------------

2. Storage Temperature Range

Specified Value	-55 to +125°C
-----------------	---------------

3. Rated Voltage

Specified Value	6.3VDC, 10VDC, 16VDC, 25VDC, 35VDC, 50VDC
-----------------	---

4. Dielectric Withstanding Voltage (Between terminals)

Specified Value	No breakdown or damage
Test Methods and Remarks	Applied voltage : Rated voltage × 3
	Duration : 1 to 5 sec.
	Charge/discharge current : 50mA max.

5. Insulation Resistance

Specified Value	10000 MΩ or 500MΩμF, whichever is smaller
Test Methods and Remarks	Applied voltage : Rated voltage
	Duration : 60±5 sec.
	Charge/discharge current : 50mA max.

6. Capacitance (Tolerance)

Specified Value	±10%
Test Methods and Remarks	Measuring frequency : 1kHz±10%
	Measuring voltage : 1±0.2Vrms
	Bias application : None

7. Dissipation Factor

Specified Value	0.1%max
Test Methods and Remarks	Measuring frequency : 1kHz±10%
	Measuring voltage : 1±0.2Vrms
	Bias application : None

8. Bending Strength

Specified Value	Appearance : No abnormality
	Capacitance change : ±5%
Test Methods and Remarks	Warp : 1mm
	Speed : 0.5mm/second
	Duration : 10 seconds
	Test board : glass epoxy resin substrate
	Thickness : 1.6mm

(Unit: mm)

Capacitance measurement shall be conducted with the board bent.

9. Adhesive Force of Terminal Electrodes

Specified Value	Terminal electrodes shall be no exfoliation or a sign of exfoliation.
Test Methods and Remarks	Applied force : 5N
	Duration : 30 ±5 seconds

▶ This catalog contains the typical specification only due to the limitation of space. When you consider the purchase of our products, please check our specification. For details of each product (characteristics graph, reliability information, precautions for use, and so on), see our Web site (<http://www.ty-top.com/>).

10. Solderability			
Specified Value	At least 95% of terminal electrode is covered by new solder.		
Test Methods and Remarks		Eutectic solder	Lead-free solder
	Solder type	H60A or H63A	Sn-3.0Ag-0.5Cu
	Solder temperature	230±5°C	245±3°C
	Duration	4±1 sec.	
11. Resistance to Soldering Heat			
Specified Value	Appearance	: No abnormality	
	Capacitance change	: ±2.5% max.	
	Dissipation factor	: Initial value	
	Insulation resistance	: Initial value	
	Withstanding voltage	(between terminals) : No abnormality	
Test Methods and Remarks	Solder temp.	: 270 ±5°C	
	Duration	: 3 ±0.5 sec.	
	Preheating conditions	: 80 to 100°C, 2 to 5 min. or 5 to 10 min. 150 to 200°C, 2 to 5 min. or 5 to 10 min.	
	Measurement shall be conducted	: 24±2hrs under the standard condition Note1	
12. Temperature Cycle (Thermal Shock)			
Specified Value	Appearance	: No abnormality	
	Capacitance change	: ±2.5% max	
	Dissipation factor	: Initial value	
	Insulation resistance	: Initial value	
	Withstanding voltage	(between terminals): No abnormality	
Test Methods and Remarks	Conditions for 1 cycle		
	Step	temperature (°C)	Time (min.)
	1	Minimum operating temperature	30±3 min.
	2	Normal temperature	2 to 3 min.
	3	Maximum operating temperature	30±3 min.
	4	Normal temperature	2 to 3 min.
Number of cycles: 5 times			
Measurement shall be conducted : 24±2hrs under the standard condition Note1			
13. Humidity (Steady state)			
Specified Value	Appearance	: No abnormality	
	Capacitance change	: ±5% max	
	Dissipation factor	: 0.5% max	
	Insulation resistance	: 50M ΩμF or 1000M Ω whichever is smaller	
Test Methods and Remarks	Temperature	: 40±2°C	
	Humidity	: 90 to 95% RH	
	Duration	: 500 +24/-0 hrs	
	Measurement shall be conducted	: 24 ±2hrs under the standard condition Note1	
14. Humidity Loading			
Specified Value	Appearance	: No abnormality	
	Capacitance change	: ±7.5% max	
	Dissipation factor	: 0.5% max	
	Insulation resistance	: 25M ΩμF or 500M Ω whichever is smaller	
Test Methods and Remarks	According to JIS C 5101-1.		
	Temperature	: 40±2°C	
	Humidity	: 90 to 95% RH	
	Duration	: 500 +24/-0 hrs	
	Applied voltage	: Rated voltage	
	Charge/discharge current	: 50mA max	
	Measurement shall be conducted	: 24 ±2hrs under the standard condition Note1	

▶ This catalog contains the typical specification only due to the limitation of space. When you consider the purchase of our products, please check our specification.
For details of each product (characteristics graph, reliability information, precautions for use, and so on), see our Web site (<http://www.ty-top.com/>).

15. High Temperature Loading

Specified Value	Appearance	: No abnormality
	Capacitance change	: $\pm 3\%$ max
	Dissipation factor	: 0.35% max
	Insulation resistance	: 50M Ω μ F or 1000M Ω whichever is smaller
Test Methods and Remarks	According to JIS C 5101-1.	
	Temperature	: Maximum operating temperature
	Duration	: 1000 +48/-0 hrs
	Applied voltage	: Rated voltage x 2
	Charge/discharge current	: 50mA max
Measurement shall be conducted	: 24 \pm 2hrs under the standard condition Note1	

Note1 Standard condition: Temperature: 5 to 35°C, Relative humidity: 45 to 85 % RH, Air pressure: 86 to 106kPa

When there are questions concerning measurement results, in order to provide correlation data, the test shall be conducted under the following condition.

Temperature: 20 \pm 2°C, Relative humidity: 60 to 70 % RH, Air pressure: 86 to 106kPa

Unless otherwise specified, all the tests are conducted under the "standard condition".

Precautions on the use of Multilayer Ceramic Capacitors

PRECAUTIONS

1. Circuit Design

◆Verification of operating environment, electrical rating and performance

1. A malfunction of equipment in fields such as medical, aerospace, nuclear control, etc. may cause serious harm to human life or have severe social ramifications.
Therefore, any capacitors to be used in such equipment may require higher safety and reliability, and shall be clearly differentiated from them used in general purpose applications.

◆Operating Voltage (Verification of Rated voltage)

1. The operating voltage for capacitors must always be their rated voltage or less.
If an AC voltage is loaded on a DC voltage, the sum of the two peak voltages shall be the rated voltage or less.
For a circuit where an AC or a pulse voltage may be used, the sum of their peak voltages shall also be the rated voltage or less.

2. Even if an applied voltage is the rated voltage or less reliability of capacitors may be deteriorated in case that either a high frequency AC voltage or a pulse voltage having rapid rise time is used in a circuit.

2. PCB Design

◆Pattern configurations (Design of Land-patterns)

1. When capacitors are mounted on PCBs, the amount of solder used (size of fillet) can directly affect the capacitor performance.
Therefore, the following items must be carefully considered in the design of land patterns:

(1) Excessive solder applied can cause mechanical stresses which lead to chip breaking or cracking. Therefore, please consider appropriate land-patterns for proper amount of solder.

(2) When more than one component are jointly soldered onto the same land, each component's soldering point shall be separated by solder-resist.

◆Pattern configurations (Capacitor layout on PCBs)

After capacitors are mounted on boards, they can be subjected to mechanical stresses in subsequent manufacturing processes (PCB cutting, board inspection, mounting of additional parts, assembly into the chassis, wave soldering of the boards, etc.). For this reason, land pattern configurations and positions of capacitors shall be carefully considered to minimize stresses.

◆Pattern configurations (Design of Land-patterns)

The following diagrams and tables show some examples of recommended land patterns to prevent excessive solder amounts.

(1) Recommended land dimensions for typical chip capacitors

● Multilayer Ceramic Capacitors : Recommended land dimensions (unit: mm)

Wave-soldering

Type		107	212	316	325
Size	L	1.6	2.0	3.2	3.2
	W	0.8	1.25	1.6	2.5
A		0.8 to 1.0	1.0 to 1.4	1.8 to 2.5	1.8 to 2.5
B		0.5 to 0.8	0.8 to 1.5	0.8 to 1.7	0.8 to 1.7
C		0.6 to 0.8	0.9 to 1.2	1.2 to 1.6	1.8 to 2.5

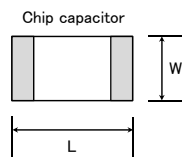
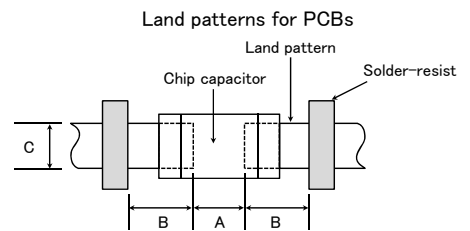

Reflow-soldering

Type		021	042	063	105	107	212	316	325	432
Size	L	0.25	0.4	0.6	1.0	1.6	2.0	3.2	3.2	4.5
	W	0.125	0.2	0.3	0.5	0.8	1.25	1.6	2.5	3.2
A		0.095~0.135	0.15~0.25	0.20~0.30	0.45~0.55	0.8~1.0	0.8~1.2	1.8~2.5	1.8~2.5	2.5~3.5
B		0.085~0.125	0.15~0.20	0.20~0.30	0.40~0.50	0.6~0.8	0.8~1.2	1.0~1.5	1.0~1.5	1.5~1.8
C		0.110~0.150	0.15~0.30	0.25~0.40	0.45~0.55	0.6~0.8	0.9~1.6	1.2~2.0	1.8~3.2	2.3~3.5

Note: Recommended land size might be different according to the allowance of the size of the product.

● LWDC: Recommended land dimensions for reflow-soldering (unit: mm)

Type		105	107	212
Size	L	0.52	0.8	1.25
	W	1.0	1.6	2.0
A		0.18~0.22	0.25~0.3	0.5~0.7
B		0.2~0.25	0.3~0.4	0.4~0.5
C		0.9~1.1	1.5~1.7	1.9~2.1

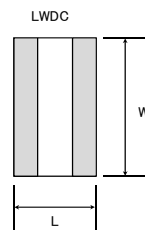

Technical considerations

▶ This catalog contains the typical specification only due to the limitation of space. When you consider the purchase of our products, please check our specification. For details of each product (characteristics graph, reliability information, precautions for use, and so on), see our Web site (<http://www.ty-top.com/>).

(2) Examples of good and bad solder application

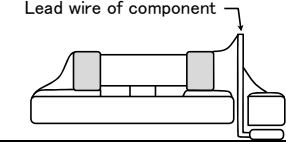
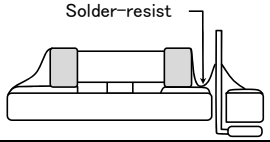
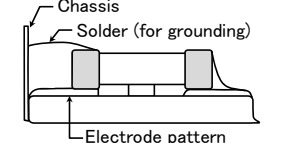
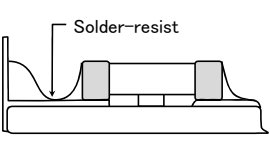
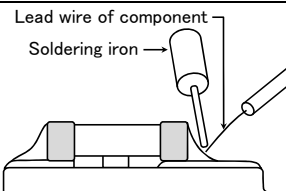
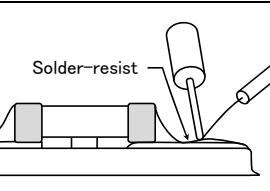
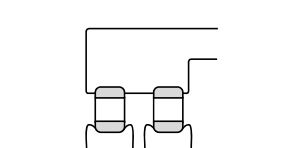
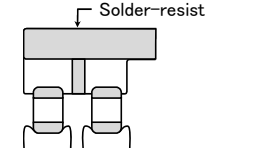
Item	Not recommended	Recommended
Mixed mounting of SMD and leaded components		
Component placement close to the chassis		
Hand-soldering of leaded components near mounted components		
Horizontal component placement		

◆ Pattern configurations (Capacitor layout on PCBs)

1-1. The following is examples of good and bad capacitor layouts ; capacitors shall be located to minimize any possible mechanical stresses from board warp or deflection.

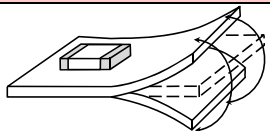
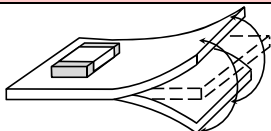
Items	Not recommended	Recommended
Deflection of board		 Place the product at a right angle to the direction of the anticipated mechanical stress.

1-2. The amount of mechanical stresses given will vary depending on capacitor layout. Please refer to diagram below.

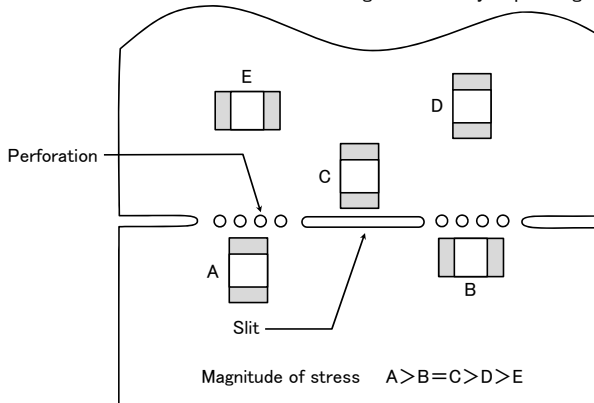

1-3. When PCB is split, the amount of mechanical stress on the capacitors can vary according to the method used. The following methods are listed in order from least stressful to most stressful: push-back, slit, V-grooving, and perforation. Thus, please consider the PCB, split methods as well as chip location.

3. Mounting

Precautions

◆ Adjustment of mounting machine

- When capacitors are mounted on PCB, excessive impact load shall not be imposed on them.
- Maintenance and inspection of mounting machines shall be conducted periodically.

◆ Selection of Adhesives

- When chips are attached on PCBs with adhesives prior to soldering, it may cause capacitor characteristics degradation unless the following factors are appropriately checked : size of land patterns, type of adhesive, amount applied, hardening temperature and hardening period. Therefore, please contact us for further information.

◆Adjustment of mounting machine

1. When the bottom dead center of a pick-up nozzle is too low, excessive force is imposed on capacitors and causes damages. To avoid this, the following points shall be considerable.
 - (1) The bottom dead center of the pick-up nozzle shall be adjusted to the surface level of PCB without the board deflection.
 - (2) The pressure of nozzle shall be adjusted between 1 and 3 N static loads.
 - (3) To reduce the amount of deflection of the board caused by impact of the pick-up nozzle, supporting pins or back-up pins shall be used on the other side of the PCB. The following diagrams show some typical examples of good and bad pick-up nozzle placement:

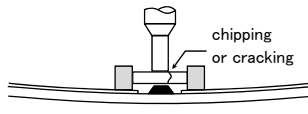
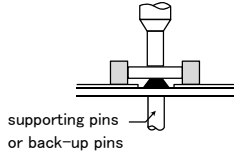
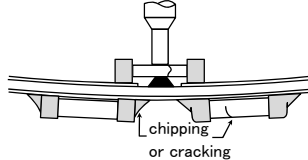
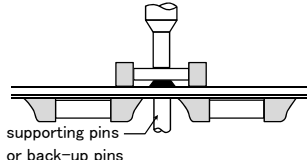
Item	Improper method	Proper method
Single-sided mounting		
Double-sided mounting		

Technical considerations

2. As the alignment pin is worn out, adjustment of the nozzle height can cause chipping or cracking of capacitors because of mechanical impact on the capacitors. To avoid this, the monitoring of the width between the alignment pins in the stopped position, maintenance, check and replacement of the pin shall be conducted periodically.

◆Selection of Adhesives

Some adhesives may cause IR deterioration. The different shrinkage percentage of between the adhesive and the capacitors may result in stresses on the capacitors and lead to cracking. Moreover, too little or too much adhesive applied to the board may adversely affect components. Therefore, the following precautions shall be noted in the application of adhesives.

- (1) Required adhesive characteristics
 - a. The adhesive shall be strong enough to hold parts on the board during the mounting & solder process.
 - b. The adhesive shall have sufficient strength at high temperatures.
 - c. The adhesive shall have good coating and thickness consistency.
 - d. The adhesive shall be used during its prescribed shelf life.
 - e. The adhesive shall harden rapidly.
 - f. The adhesive shall have corrosion resistance.
 - g. The adhesive shall have excellent insulation characteristics.
 - h. The adhesive shall have no emission of toxic gasses and no effect on the human body.
- (2) The recommended amount of adhesives is as follows;

[Recommended condition]

Figure	212/316 case sizes as examples
a	0.3mm min
b	100 to 120 μm
c	Adhesives shall not contact land

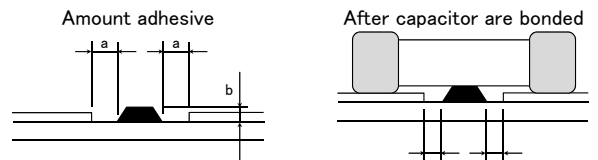

4. Soldering

◆Selection of Flux

- Since flux may have a significant effect on the performance of capacitors, it is necessary to verify the following conditions prior to use;
- (1) Flux used shall be less than or equal to 0.1 wt% (in Cl equivalent) of halogenated content. Flux having a strong acidity content shall not be applied.
 - (2) When shall capacitors are soldered on boards, the amount of flux applied shall be controlled at the optimum level.
 - (3) When water-soluble flux is used, special care shall be taken to properly clean the boards.

Precautions

◆Soldering

Temperature, time, amount of solder, etc. shall be set in accordance with their recommended conditions.
 Sn-Zn solder paste can adversely affect MLOC reliability.
 Please contact us prior to usage of Sn-Zn solder.

◆Selection of Flux

- 1-1. When too much halogenated substance (Chlorine, etc.) content is used to activate flux, or highly acidic flux is used, it may lead to corrosion of terminal electrodes or degradation of insulation resistance on the surfaces of the capacitors.
- 1-2. Flux is used to increase solderability in wave soldering. However if too much flux is applied, a large amount of flux gas may be emitted and may adversely affect the solderability. To minimize the amount of flux applied, it is recommended to use a flux-bubbling system.
- 1-3. Since the residue of water-soluble flux is easily dissolved in moisture in the air, the residues on the surfaces of capacitors in high humidity conditions may cause a degradation of insulation resistance and reliability of the capacitors. Therefore, the cleaning methods and the capability of the machines used shall also be considered carefully when water-soluble flux is used.

Technical considerations

▶ This catalog contains the typical specification only due to the limitation of space. When you consider the purchase of our products, please check our specification. For details of each product (characteristics graph, reliability information, precautions for use, and so on), see our Web site (<http://www.ty-top.com/>).

◆ Soldering

- Ceramic chip capacitors are susceptible to thermal shock when exposed to rapid or concentrated heating or rapid cooling.
- Therefore, the soldering must be conducted with great care so as to prevent malfunction of the components due to excessive thermal shock.
- Preheating : Capacitors shall be preheated sufficiently, and the temperature difference between the capacitors and solder shall be within 130°C.
- Cooling : The temperature difference between the capacitors and cleaning process shall not be greater than 100°C.

[Reflow soldering]

【Recommended conditions for eutectic soldering】

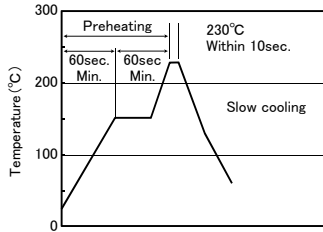

【Recommended condition for Pb-free soldering】

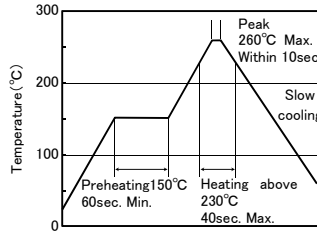

Caution

- ① The ideal condition is to have solder mass (fillet) controlled to 1/2 to 1/3 of the thickness of a capacitor.
- ② Because excessive dwell times can adversely affect solderability, soldering duration shall be kept as close to recommended times as possible. soldering for 2 times.

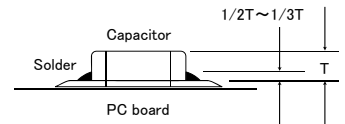

[Wave soldering]

【Recommended conditions for eutectic soldering】

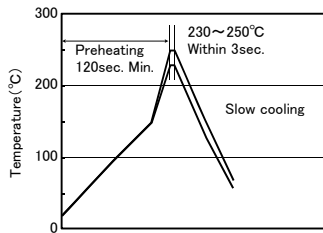

【Recommended condition for Pb-free soldering】

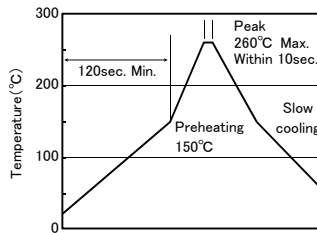

Caution

- ① Wave soldering must not be applied to capacitors designated as for reflow soldering only. soldering for 1 times.

[Hand soldering]

【Recommended conditions for eutectic soldering】

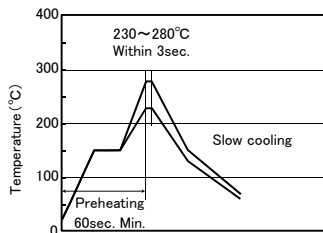

【Recommended condition for Pb-free soldering】

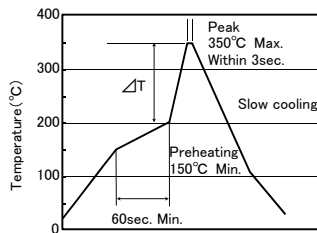

316type or less	$\Delta T \leq 150^{\circ}\text{C}$
-----------------	-------------------------------------

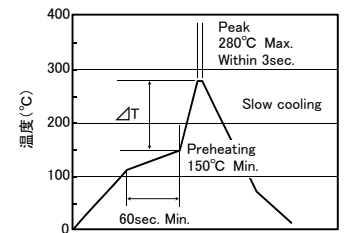

325type or more	$\Delta T \leq 130^{\circ}\text{C}$
-----------------	-------------------------------------

Caution

- ① Use a 50W soldering iron with a maximum tip diameter of 1.0 mm.
- ② The soldering iron shall not directly touch capacitors. soldering for 1 times.

5. Cleaning	
Precautions	<p>◆Cleaning conditions</p> <ol style="list-style-type: none"> When PCBs are cleaned after capacitors mounting, please select the appropriate cleaning solution in accordance with the intended use of the cleaning. (e.g. to remove soldering flux or other materials from the production process.) Cleaning condition shall be determined after it is verified by using actual cleaning machine that the cleaning process does not affect capacitor's characteristics.
Technical considerations	<ol style="list-style-type: none"> The use of inappropriate cleaning solutions can cause foreign substances such as flux residue to adhere to capacitors or deteriorate their outer coating, resulting in a degradation of the capacitor's electrical properties (especially insulation resistance). Inappropriate cleaning conditions (insufficient or excessive cleaning) may adversely affect the performance of the capacitors. In the case of ultrasonic cleaning, too much power output can cause excessive vibration of PCBs which may lead to the cracking of capacitors or the soldered portion, or decrease the terminal electrodes' strength. Therefore, the following conditions shall be carefully checked; Ultrasonic output : 20 W/l or less Ultrasonic frequency : 40 kHz or less Ultrasonic washing period : 5 min. or less

6. Resin coating and mold	
Precautions	<ol style="list-style-type: none"> With some type of resins, decomposition gas or chemical reaction vapor may remain inside the resin during the hardening period or while left under normal storage conditions resulting in the deterioration of the capacitor's performance. When a resin's hardening temperature is higher than capacitor's operating temperature, the stresses generated by the excessive heat may lead to damage or destruction of capacitors. The use of such resins, molding materials etc. is not recommended.

7. Handling	
Precautions	<p>◆Splitting of PCB</p> <ol style="list-style-type: none"> When PCBs are split after components mounting, care shall be taken so as not to give any stresses of deflection or twisting to the board. Board separation shall not be done manually, but by using the appropriate devices. <p>◆Mechanical considerations</p> <p>Be careful not to subject capacitors to excessive mechanical shocks.</p> <p>(1) If ceramic capacitors are dropped onto a floor or a hard surface, they shall not be used.</p> <p>(2) Please be careful that the mounted components do not come in contact with or bump against other boards or components.</p>

8. Storage conditions	
Precautions	<p>◆Storage</p> <ol style="list-style-type: none"> To maintain the solderability of terminal electrodes and to keep packaging materials in good condition, care must be taken to control temperature and humidity in the storage area. Humidity should especially be kept as low as possible. <ul style="list-style-type: none"> Recommended conditions Ambient temperature : Below 30°C Humidity : Below 70% RH The ambient temperature must be kept below 40°C. Even under ideal storage conditions, solderability of capacitor is deteriorated as time passes, so capacitors shall be used within 6 months from the time of delivery. Ceramic chip capacitors shall be kept where no chlorine or sulfur exists in the air. The capacitance values of high dielectric constant capacitors will gradually decrease with the passage of time, so care shall be taken to design circuits. Even if capacitance value decreases as time passes, it will get back to the initial value by a heat treatment at 150°C for 1 hour.
Technical considerations	<p>If capacitors are stored in a high temperature and humidity environment, it might rapidly cause poor solderability due to terminal oxidation and quality loss of taping/packaging materials. For this reason, capacitors shall be used within 6 months from the time of delivery. If exceeding the above period, please check solderability before using the capacitors.</p>

※RCR-2335B (Safety Application Guide for fixed ceramic capacitors for use in electronic equipment) is published by JEITA.

Please check the guide regarding precautions for deflection test, soldering by spot heat, and so on.